

DuPont™ Enerfoam™ Professional Foam Sealant

Installation Recommendations

SYSTEM OVERVIEW

General Information

The instructions outlined here describe how to use DuPont™ Enerfoam™ Professional Foam Sealant* to fill gaps and cracks around the home.

Designed to form a durable, airtight and water-resistant seal in gaps up to 3" (75 mm), Enerfoam™ expands to take the shape of cracks and voids, forming a permanent, airtight and water-resistant bond to wood, brick, vinyl, foam board, metal and most plastics.** Once cured, it remains soft and flexible, permitting natural expansion and contraction of surrounding surfaces.

In the U.S., Enerfoam™ is also recognized as an effective fireblock penetration sealant. Applications include adhering insulated concrete forms, architectural foam and drywall, and sealing cracks and voids such as pipe penetrations. The foam expands only enough to generate an effective seal, retaining elasticity as the structure expands and compresses. To determine the amount of Enerfoam™ required for an application, see Table 1.

TABLE 1: Estimated Yields for Enerfoam™ Professional Foam Sealant

Can Size, oz (g)	Delivery	Yield ⁽¹⁾ , linear feet (m)	Estimated Caulk Equivalency, quart tubes
24 (680)	Reusable straw	775 (236)	18
24 (680)	Gun	970 (296)	22
30 (850)	Gun	1,450 (442)	33

⁽¹⁾ Estimated yield under ideal conditions, 3/8" (1 cm) diameter bead.

Safety and Conditions of Use

- Read the label and Material Safety Data Sheet carefully before use.
- Enerfoam™ contains isocyanate and a flammable blowing agent. Vapor may travel to other rooms. Ensure adequate ventilation. Shut off all pilot lights and extinguish open flames; eliminate all sources of ignition before use. Do not smoke or use lighters or matches while dispensing foam.
- Do not breathe vapor or mist. Use in well-ventilated areas or wear proper respiratory protection. Isocyanate is irritating to the eyes, skin and respiratory system, and may cause sensitization by inhalation or skin contact.

- Enerfoam™ is very sticky and will adhere to most surfaces and skin. Do not get foam on skin. Wear long sleeves, gloves, and goggles or safety glasses. Cured foam must be mechanically removed or allowed to wear off in time.
- The contents are under pressure. The can may burst if left in areas susceptible to high temperatures, such as motor vehicles, or near radiators, stoves or other sources of heat. Do not place can in hot water. Do not puncture, incinerate or store at temperatures above 120°F (49°C).
- Enerfoam™ may be used on vinyl, wood, composite and metal (aluminum or steel) substrates. The product adheres best when surfaces are clean and free of oil or chemicals.
- Extremely cold temperatures can affect dispensing performance.
- Skin of cured foam can discolor if exposed to direct or continuous sunlight for 24 hours or more. Foam should be painted or coated if prolonged exposure to sunlight is expected.
- Using one of the PRO Series foam dispensing guns (shown in Figure 1) simplifies the application of Enerfoam™. In addition to enabling pinpoint application control, an airtight and moisture-tight seal between the gun and the can prevents the foam from curing and blocking the dispensing valve.

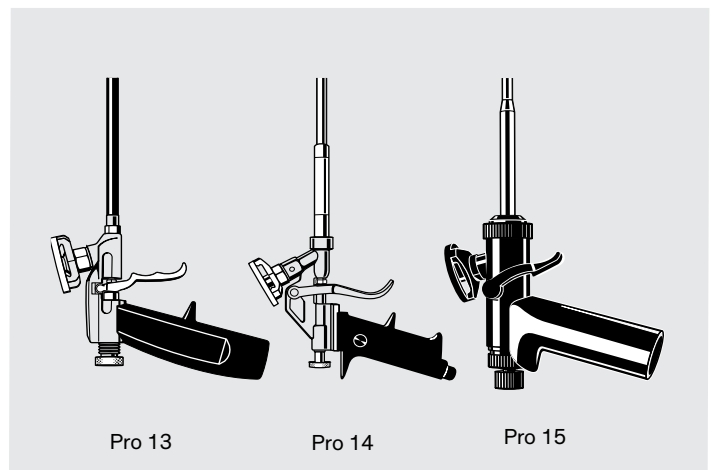

Figure 1

* DuPont™ Enerfoam™ Professional Foam Sealant is a former product of The Dow Chemical Company.

** For cavities, cracks and penetrations larger than 3" (75 mm), DuPont recommends Froth-Pak™ Foam Sealant or Froth-Pak™ Foam Insulation. For window and door framework, minimal-expanding DuPont™ Great Stuff Pro™ Window & Door Polyurethane Foam Sealant is proven not to distort or bow the framework when properly applied.

INSTALLATION

Preparation

1. Read and follow the Safety and Conditions of Use instructions below. Wear gloves, safety glasses or goggles and long sleeves. Provide good ventilation and eliminate all sources of ignition.
2. Shake can vigorously for 1 minute before dispensing and between uses.
3. **Gun-applied version:**
Invert can and screw foam dispensing gun assembly firmly onto valve as shown in Figure 2. Screw until finger-tight; do not overtighten (Figure 3). When changing cans using the foam dispensing gun, tighten the flow control knob before removing the empty can (Figure 4). Use DuPont™ Great Stuff Pro™ Foam Cleaner to remove any residual foam from the attachment area before attaching fresh can.

Straw-applied version:

Attach the nozzle by twisting it clockwise into the valve.



Figure 2



Figure 3

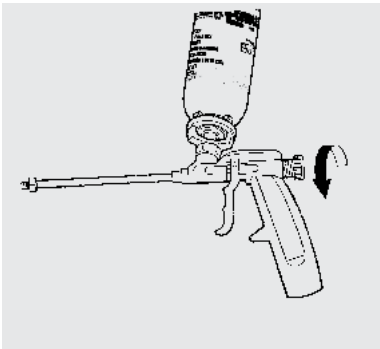
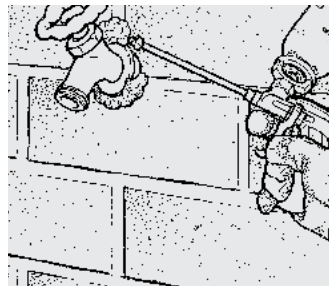
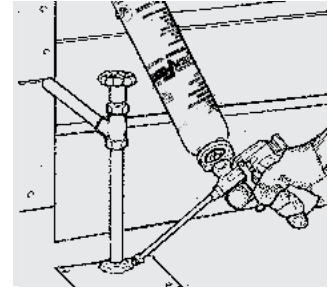

Figure 4



Outdoor water faucet



Fireplace gas line

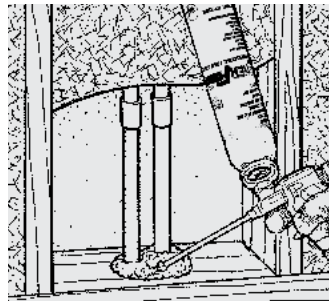

Pipe penetration

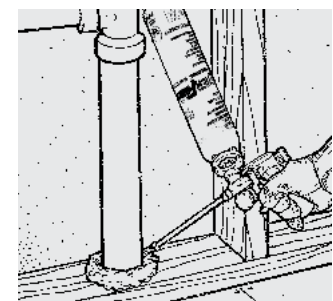

Sewer plumbing penetration

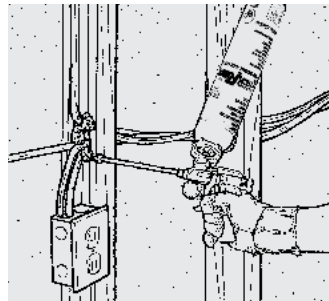

Electrical wire penetration

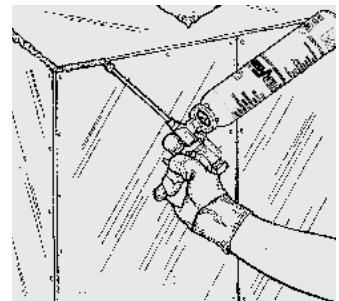

Wall-ceiling juncture

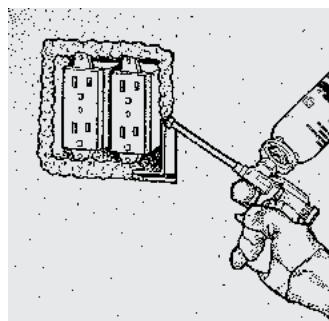

Electrical outlet*

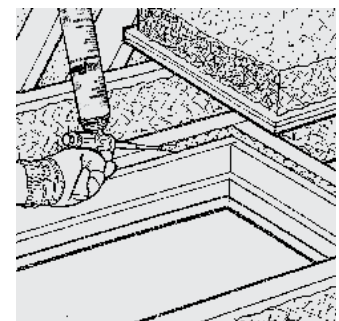

Attic hatch

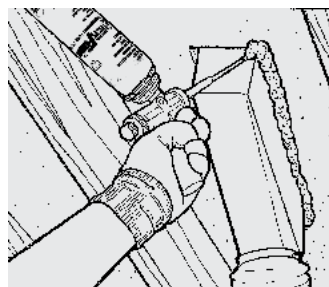

HVAC vent

*Foam should be applied around the edges of the metal box. Do not apply within the metal box.

Gun-applied version:

1. Adjust flow control screw on back of gun to an open position. Immediately press trigger to fill gun with foam while dispensing into an appropriate waste receptacle. **Caution:** Do not inject the foam sealant into blind six-sided cavities, such as window mullions. The foam must be exposed to atmospheric moisture to thoroughly cure.
2. Keeping can inverted, insert applicator nozzle into the penetration to be filled and begin dispensing foam slowly. Fill gap less than 1/3 full to allow for proper expansion. **Tip:** Apply foam in a continuous bead, with no voids or breaks, to achieve an effective seal.
3. The foam dispensing gun is recommended to control size of the foam bead (from 1/8" to 3" [3 mm to 75 mm]). This is achieved by squeezing the trigger on the foam dispensing gun or by adjusting the flow control knob on the back of the gun to set how far the trigger can be pulled (Figure 5).

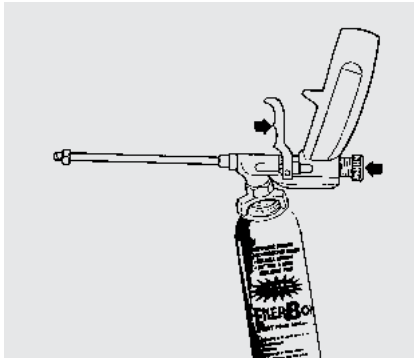

4. If the gap is overfilled, stuff excess cured foam into the gap with a blunt tool or trim away with a sharp knife. Foam will be tack-free in less than 20 minutes and can be trimmed in 1/2 hour. It is fully cured 1 hour after application.* **Tip:** Using grease or petroleum jelly in the adapter of the gun may reduce possibility of foam gluing the can on the gun.
5. Clean foam dispensing gun periodically by rubbing the end on soft wood to free it from foam. Do not use a sharp object to clean foam dispensing gun. Use a solvent cleaner such as DuPont™ Great Stuff Pro™ Foam Cleaner between extended periods of non-use. **Tip:** Treat your gun like a tool. The better you take care of it, the longer it will last.
6. To store partially used can, tighten flow control screw closed and store can upright with gun attached. Use can within 30 days of initial use. **Tip:** Always close the flow control knob when the gun is not in use.
7. To reuse, shake can vigorously for 1 minute before dispensing and follow dispensing instructions stated above.

Straw-applied version:

1. Attach the nozzle by twisting it clockwise into the valve. Press the button until the appropriate size of foam bead is achieved. Fill gap less than 1/3 full to allow for proper expansion.
2. If the gap is overfilled, stuff excess cured foam into the gap with a blunt tool or trim away with a sharp knife. Foam will be tack-free in less than 20 minutes and can be trimmed in 1/2 hour. It is fully cured 1 hour after application.**
3. Clean straw periodically by rubbing the end on soft wood to free it from foam.
4. When finished, bend the straw back onto the plug on top of the trigger assembly. The plug prevents moisture from entering and curing inside the straw or valve.
5. To use after storage, gently rotate or twist the straw to break the adhesive bond of the foam. Pull the straw off of the plug and dispense.

Clean Up & Disposal

- On solid surfaces, uncured foam can be dissolved with Great Stuff Pro™ Foam Cleaner. Cured foam must be mechanically removed or allowed to wear off in time.
- To clean foam dispensing gun, install a can of Great Stuff Pro™ Foam Cleaner to the foam dispensing gun and spray until all foam is blown out of the foam dispensing gun and only cleaner is visible (approximately half the can of cleaner will be used). Allow the gun to sit for several minutes and repeat with a second flush.
- Do not leave a can of cleaner mounted on the foam dispensing gun. This will dissolve the lip seals inside the gun and render it useless. Foam escaping at the handle or trigger indicates a faulty seal. If this happens, the gun should be replaced. If the foam dispensing gun has not been cleaned, add a new can of Enerfoam™ Professional Foam Sealant immediately. If left without a can attached, exposure to air and moisture will cause the foam in the gun to cure.
- Disposal of full or partially used aerosol cans must be in compliance with all federal, state/provincial and local laws and regulations. Regulations vary in different locations. Empty cans are not considered hazardous waste and may be disposed of as nonhazardous household waste.

*Dependent upon temperature, relative humidity and size of foam bead



**For more information visit
building.dupont.com/enerfoam
or call 1-866-583-2583**

NOTICE: No freedom from any patent owned by DuPont or others is to be inferred. Because use conditions and applicable laws may differ from one location to another and may change with time, Customer is responsible for determining whether products and the information in this document are appropriate for Customer's use and for ensuring that Customer's workplace and disposal practices are in compliance with applicable laws and other government enactments. The product shown in this literature may not be available for sale and/or available in all geographies where DuPont is represented. The claims made may not have been approved for use in all countries or regions. DuPont assumes no obligation or liability for the information in this document. References to "DuPont" or the "Company" mean the DuPont legal entity selling the products to Customer unless otherwise expressly noted. NO EXPRESS WARRANTIES ARE GIVEN EXCEPT FOR ANY APPLICABLE WRITTEN WARRANTIES SPECIFICALLY PROVIDED BY DUPONT. ALL IMPLIED WARRANTIES INCLUDING THOSE OF MERCHANTABILITY AND FITNESS FOR A PARTICULAR PURPOSE ARE EXPRESSLY EXCLUDED. The buyer assumes all risks as to the use of the material. Buyer's exclusive remedy or any claim (including without limitations, negligence, strict liability, or tort) shall be limited to the refund of the purchase price of the material. Failure to strictly adhere to any recommended procedures shall release DuPont Specialty Products USA, LLC or its affiliates, of all liability with respect to the materials or the use thereof. The information herein is not intended for use by non-professional designers, applicators or other persons who do not purchase or utilize this product in the normal course of their business.

CAUTION: When cured, these products are combustible and will burn if exposed to open flame or sparks from high-energy sources. Do not expose to temperatures above 240°F (116°C). For more information, consult (Material) Safety Data Sheet ((M)SDS), call DuPont at 1-866-583-BLUE (2583) or contact your local building inspector. In an emergency, call 1-989-636-4400 in the U.S. or 1-519-339-3711 in Canada. The blowing agent contained within this product can exhibit vapor flame limits under the right conditions. If specific operating conditions are such that concentrations of the blowing agent above the lower flammable limit can accumulate in areas with high relative humidity and in the presence of high-energy electrical discharges or other ignition sources, additional measures such as increased ventilation or coded electrical equipment (class one, division two) may be warranted. DO NOT SMOKE DURING USE. DO NOT USE NEAR ANY OPEN FLAME OR ELECTRICAL SOURCE. OUTDOOR USE ONLY. INDOOR USE INCREASES LIKELIHOOD OF IGNITABLE CONDITIONS. INSTASTIK™ Quik Set Commercial Roofing Adhesive contains isocyanate and a blowing agent. Read the label and (Material) Safety Data Sheet ((M)SDS) carefully before use. Wear gloves, and goggles or safety glasses. Provide adequate ventilation or wear proper respiratory protection. Contents under pressure. For outside use only.

Great Stuff Pro™, Enerfoam™ and Enerbond™ sealant and adhesive products contain isocyanate and a flammable blowing agent. Read the label and Material Safety Data Sheet carefully before use. Eliminate all sources of ignition before use. Wear gloves, and safety glasses or goggles. Provide adequate ventilation or wear proper respiratory protection. Contents under pressure.

Great Stuff Pro™ Foam Cleaner is flammable and contains acetone and propane. Read the label and Material Safety Data Sheet carefully before use. Eliminate all sources of ignition before use. Wear gloves, and goggles or safety glasses. Provide adequate ventilation or wear proper respiratory protection. Contents under pressure.

Building and/or construction practices unrelated to insulation could greatly affect moisture and the potential for mold formation. No material supplier including DuPont can give assurance that mold will not develop in any specific system.

DuPont™, the DuPont Oval Logo, and all trademarks and service marks denoted with ™, SM or ® are owned by affiliates of DuPont de Nemours, Inc. unless otherwise noted. © 2019 DuPont.

43-D100375-enUS-0619 CDP